



ADVANCED LOUDSPEAKERS

TRUE RIBBONS FOR THE TRUTH
NEVER EXPERIENCED BEFORE



RAAL IS PROUD TO PRESENT THE PINNACLE OF CONTEMPORARY TRUE RIBBON TRANSDUCER DESIGN. IT DEFINES NEW LIMITS TO AN OLD CONCEPT. SUPERIOR IN SOUND QUALITY AND RELIABILITY, IT DEALS WITH EVERY TASK BY INCOMPARABLE DOMINANCE. THE UNCOMPRESSED REPRODUCTION OF THE SIGNAL DYNAMICS, IS WHAT MAKES IT BETTER THAN ANY CORRUGATED TRUE RIBBON DESIGN AND, STILL, IT HAS ONLY 4 MICROMETER ALUMINUM FOIL. NEW IDEAS, SCIENCE, ART AND EXPERIENCE, BROUGHT TOGETHER. PAINSTAKINGLY BRED BY CONNOISSEURS FOR THEIR OWN KIND.

MODEL

70-10 *FLATFOIL*

FEATURES :

- SPECIAL *FLATFOIL*[®] PURE ALUMINIUM RIBBON
- SPECIAL *SYMMLEAD*[®] LOW INDUCTANCE SIGNAL PATH
- SPECIAL *EQUAFIELD*[®] NDFEB MAGNETIC STRUCTURE
- SPECIAL "NON-WAVE-GUIDE" INOX FRONT PLATE
- SUPER-FAST SETTLING TIME
- FLAT FREQUENCY RESPONSE
- LOW DISTORTION
- HIGHEST RELIABILITY
- HIGH SIGNAL POWER HANDLING

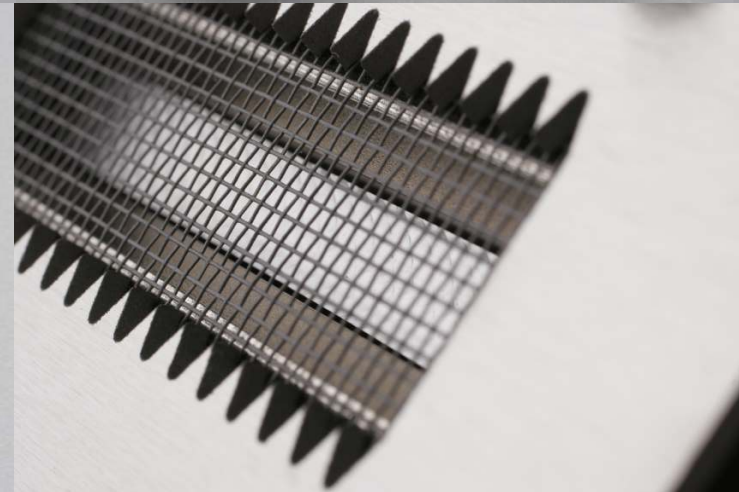
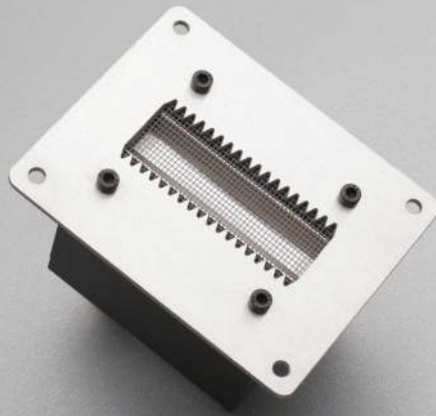
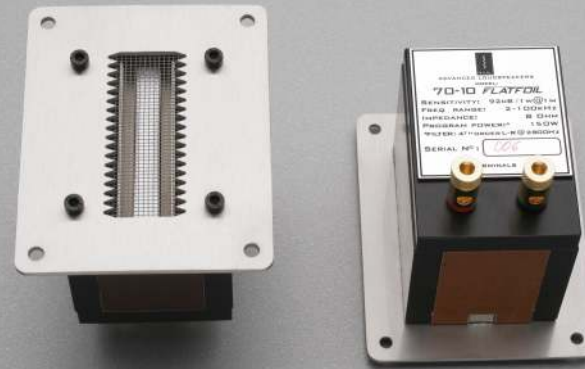
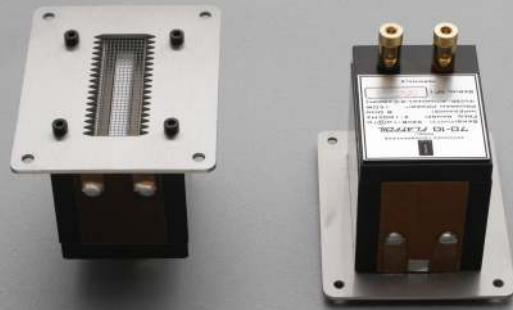

RAAL

70-10 *FLATFOIL*®

SPECIFICATIONS:

RIBBON MATERIAL:	ALUMINIUM
RIBBON DIMENSIONS:	(70 x 9.5 x 0.004) MM
RIBBON MASS:	0.0075 G
RIBBON AREA:	6.65 CM SQ.
GAP INDUCTION:	0,62 T
FREQUENCY RESPONSE:	2 KHZ ~ 100 KHZ
SENSITIVITY:	92 DB / 1M / 2,83 V
IMPEDANCE:	8 OHM
PROGRAM POWER HANDLING:	150 W*
*RECOMMENDED CROSSOVER:	4TH ORDER L-R @ 2800 HZ

RAAL 70-10 *FLATFOIL*®

PERFORMANCE:

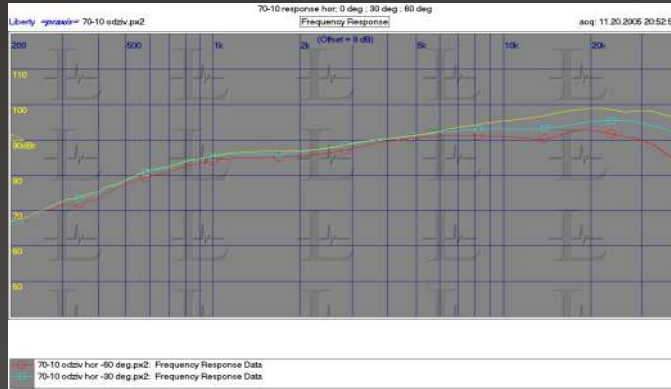

SPL VS FREQ. & HORIZONTAL DISPERSION

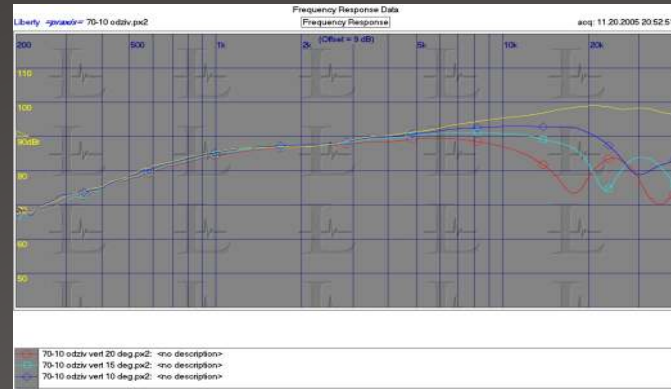

SPL VS FREQ. & VERTICAL DISPERSION

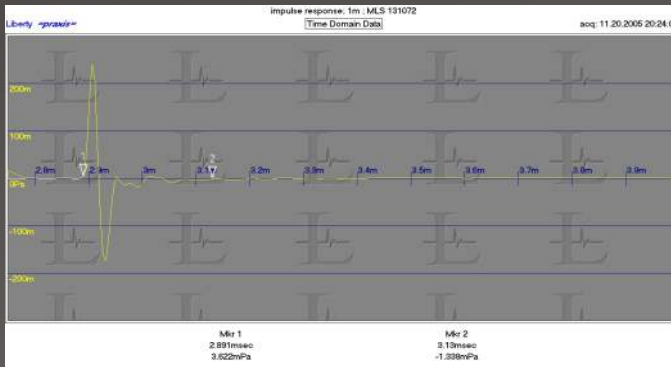

IMPULSE RESPONSE

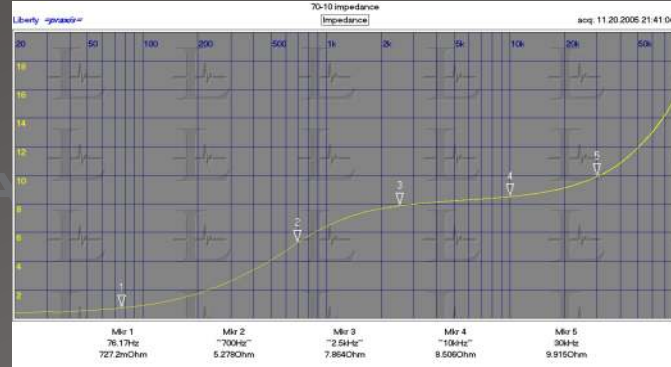

IMPEDANCE

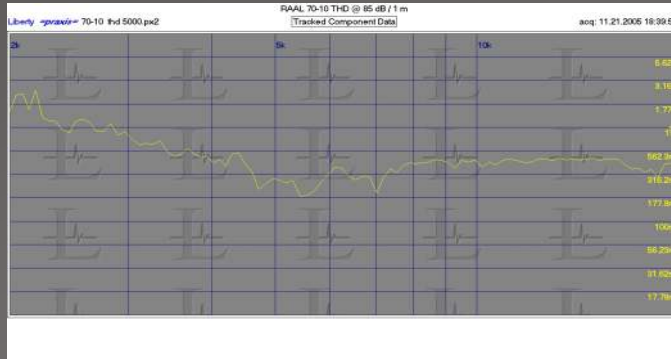

THD

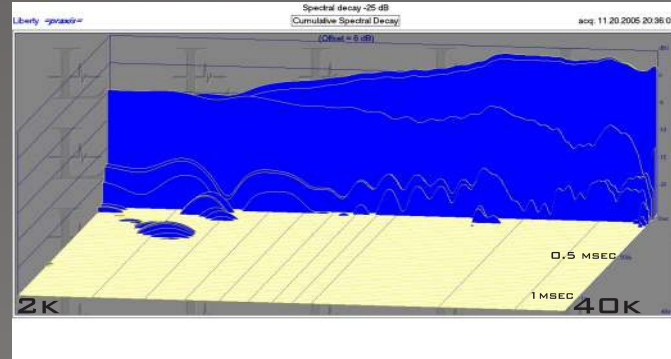

SPECTRAL DECAY

RAAL

70-10 *FLATFOIL*[®]

MECHANICAL DRAWING

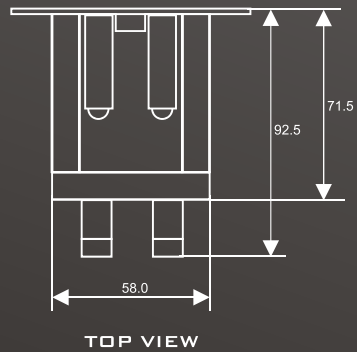
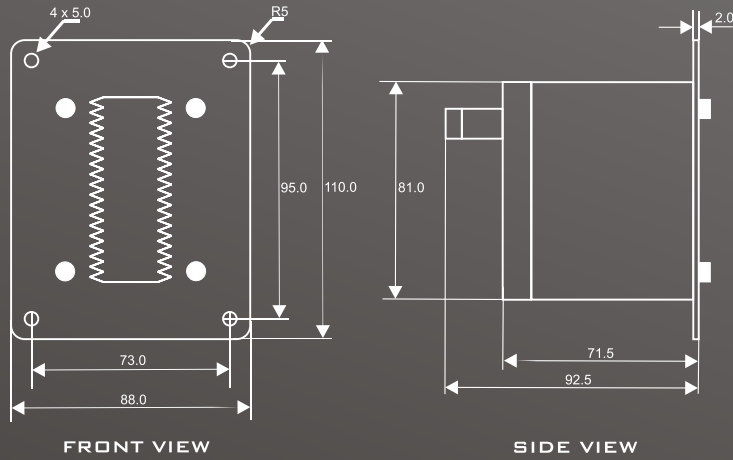

BAFFLE HOLE: 83 MM X 61 MM

WEIGHT: 1.55 KG

ALL DIMENSIONS IN MILLIMETERS

+/- 0.3 MM

RECOMMENDED CROSSOVER NETWORK

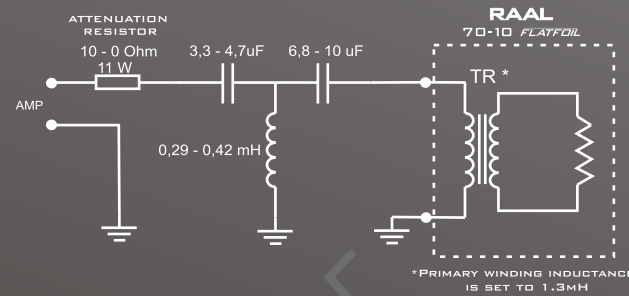

THE EXACT VALUES SHOULD BE DETERMINED BY ACOUSTIC MEASUREMENTS WITH THE BASS-MID UNIT.

RAAL

REPLACING THE RIBBON REPLACEMENT KIT ON RAAL RIBBON SPEAKERS

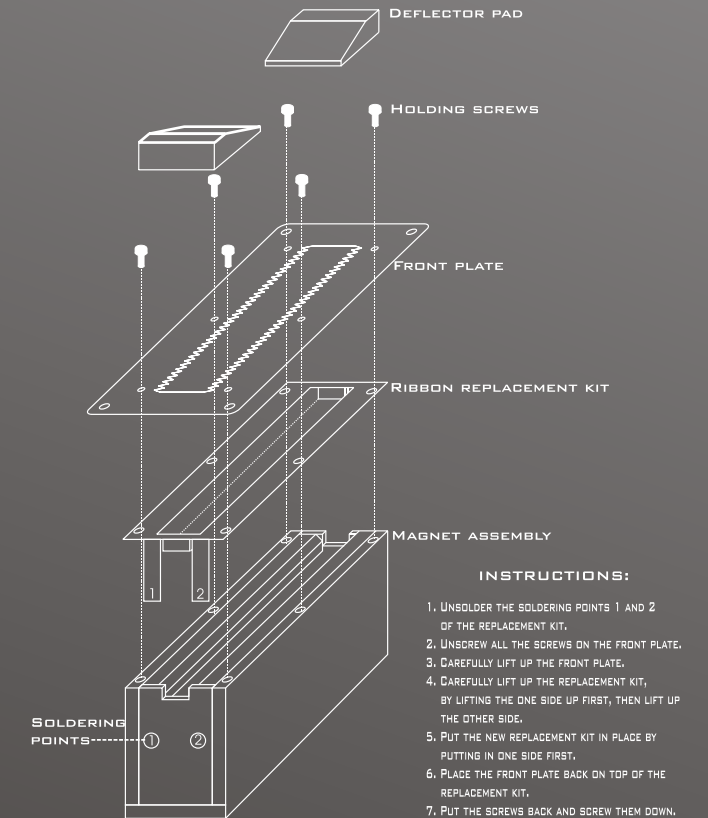

RAAL ADVANCED LOUDSPEAKERS D.O.O.

DJORDJA SIMEONOVICA 4
19000 ZAJECAR
SERBIA AND MONTENEGRO

TEL: +381 64 144 1111

LINK TO:
WWW.RAALRIBBON.COM